

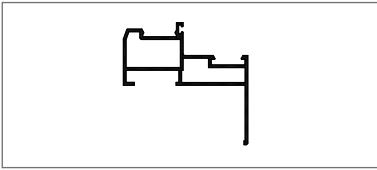

PERSIANE *SUTTER*

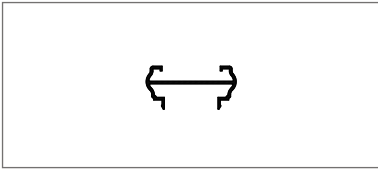
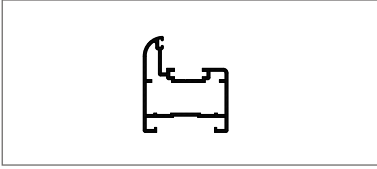
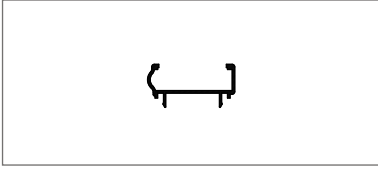
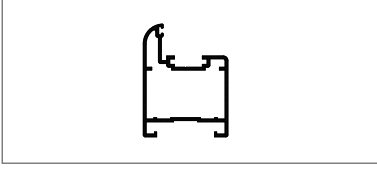
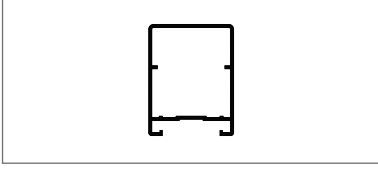
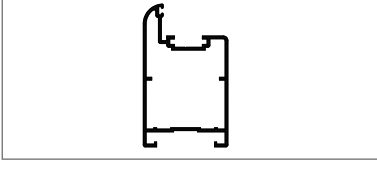
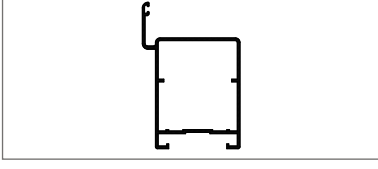
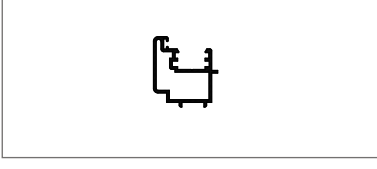
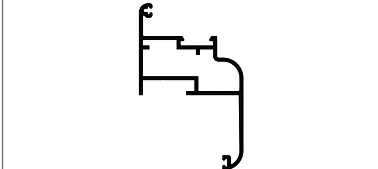
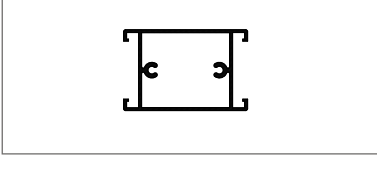
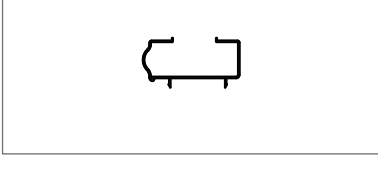
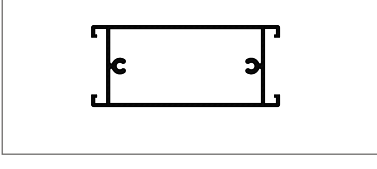
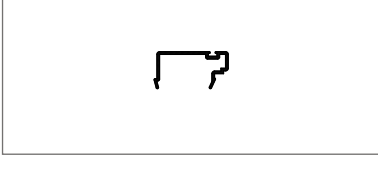
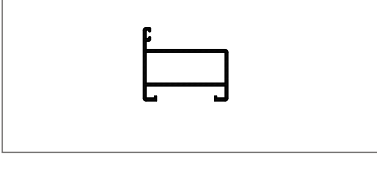
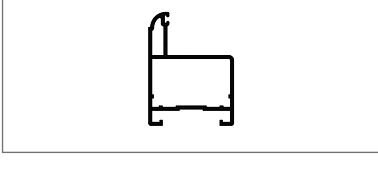

S Y N T H E S I S

PRS

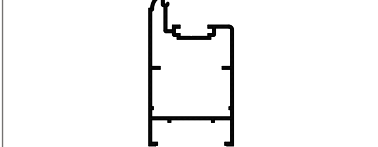
DS 4501 gr/m 988	pag. 5		DS 4510 gr/m 427	pag. 9	
DS 4502 gr/m 856	6		DS 4511 gr/m 383	9	
DS 4503 gr/m 926	6		DS 4513 gr/m 840	6	
DS 4504 gr/m 1058	6		DS 4514 gr/m 966	6	
DS 4505 gr/m 610	6		DS 4515 gr/m 1053	5	
DS 4506 gr/m 1115	8		DS 4516 gr/m 423	9	
DS 4507 gr/m 1391	8		DS 4520 gr/m 330	8	
DS 4508 gr/m 636	8		DS 4533 gr/m 861	7	
DS 4509 gr/m 307	8		DS 4564 gr/m 1085	7	

DS 4593 gr/m 970	pag. 7		F382 gr/m 1264	pag. 8	
DS 4594 gr/m 745	pag. 7		F391 gr/m 1340	pag. 8	
DS 4595 gr/m 1015	pag. 7		F392 gr/m 384	pag. 9	
DS 4596 gr/m 610	pag. 7		8/34 gr/m 349	pag. 10	
zn6-4500 I gr/m 910	pag. 5		8/70 gr/m 446	pag. 10	
zn6-45040 gr/m 149	pag. 5		8/83 gr/m 410	pag. 10	
zn6-4505 I gr/m 124	pag. 5		8/157 gr/m 500	pag. 10	
zn6-45096 gr/m 80	pag. 5		8/223 gr/m 532	pag. 10	
M18-116 gr/m 168	pag. 5		11/38 gr/m 286	pag. 9	

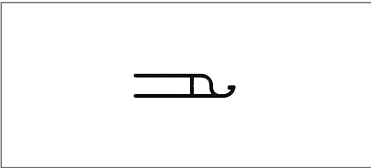
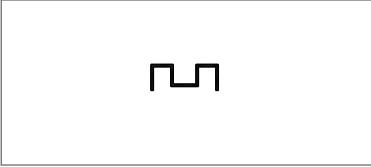
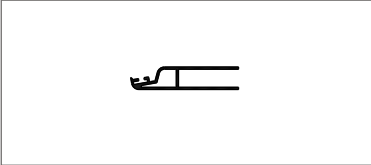
	pag.	
18/2856 gr/m 381	9	
18/3389 gr/m 311	9	
18/3390 gr/m 446	9	

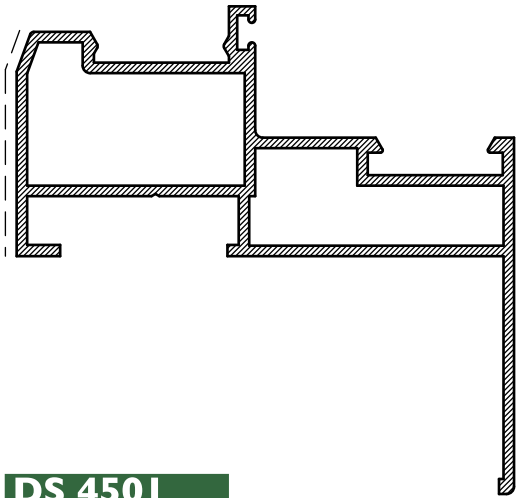

DS 450 I

gr/m 988

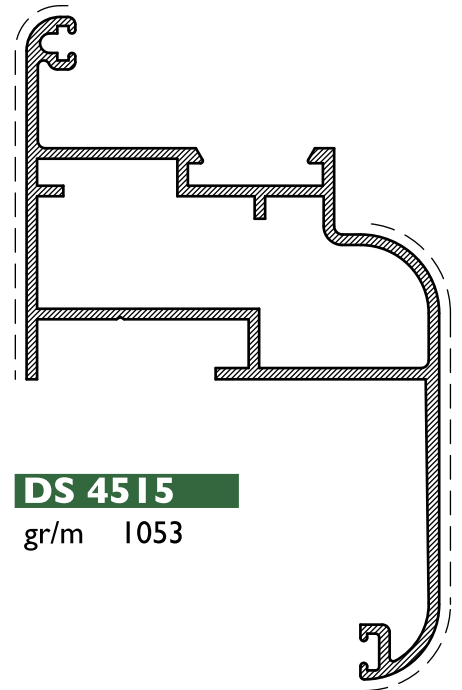

DS 4515

gr/m 1053

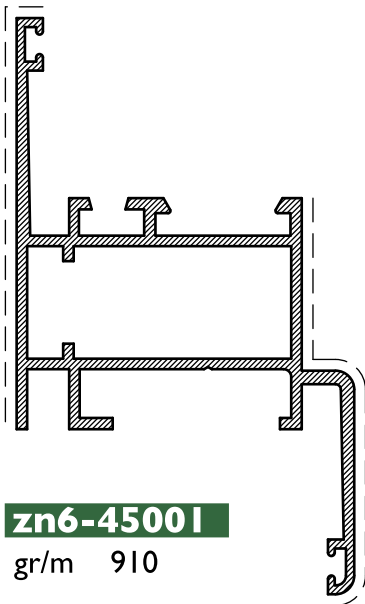

zn6-4500 I

gr/m 910



M18-116

gr/m 168



zn6-45040

gr/m 149

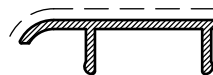

zn6-4505 I

gr/m 124

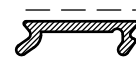

zn6-45096

gr/m 80

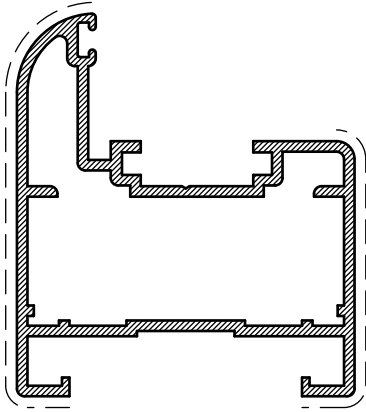

DS 4502

gr/m 856

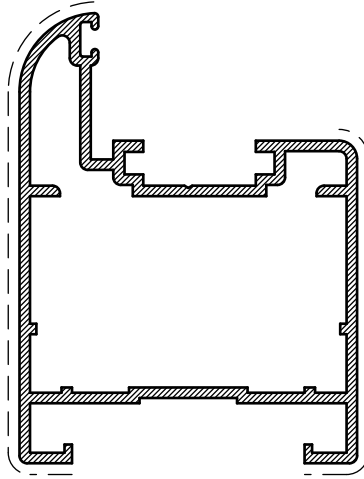

DS 4503

gr/m 926

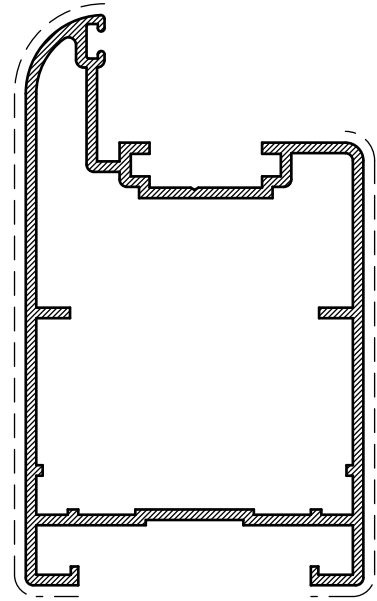

DS 4504

gr/m 1058

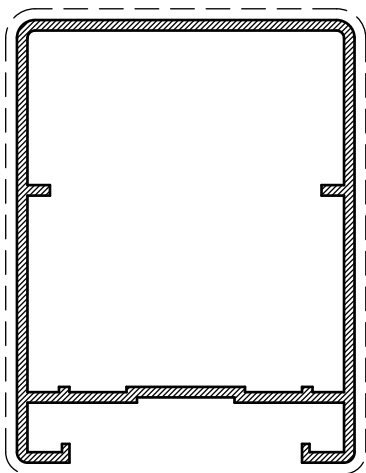

DS 4513

gr/m 840

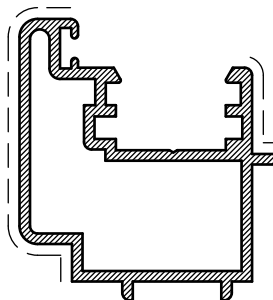

DS 4505

gr/m 610

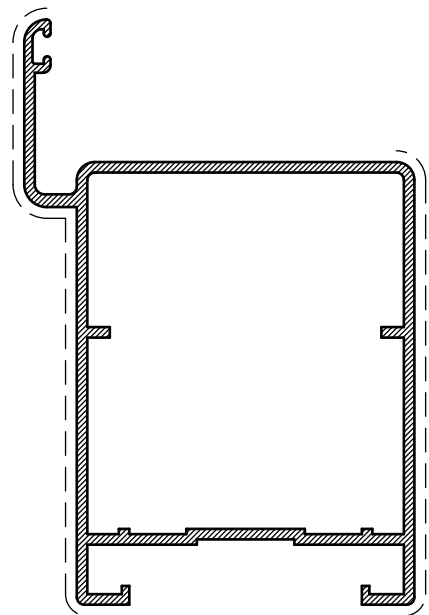

DS 4514

gr/m 966

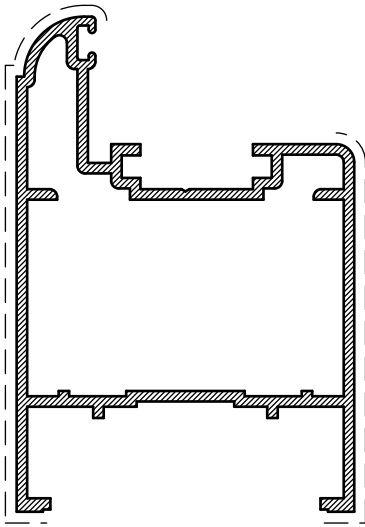

DS 4593

gr/m 970

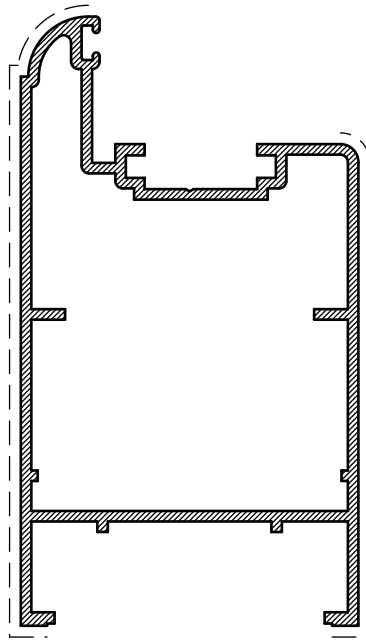

DS 4564

gr/m 1085

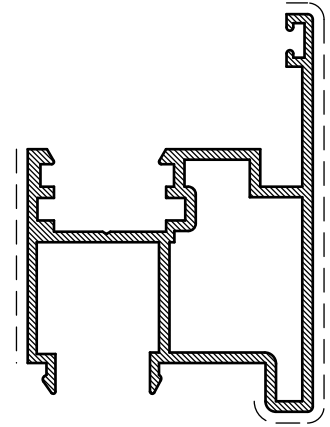

DS 4594

gr/m 745

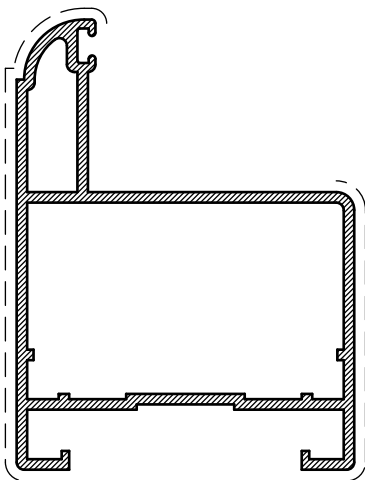

DS 4533

gr/m 861

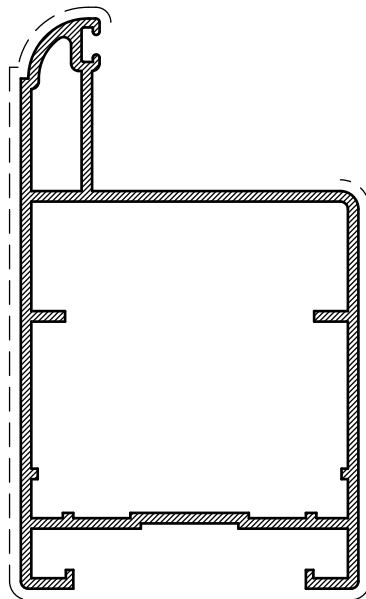

DS 4595

gr/m 1015

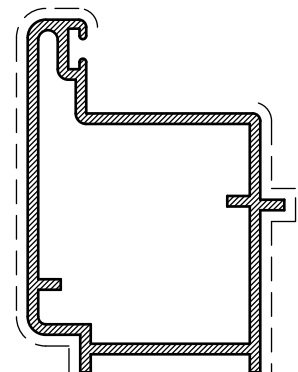

DS 4596

gr/m 610

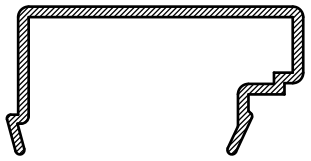

DS 4509

gr/m 307

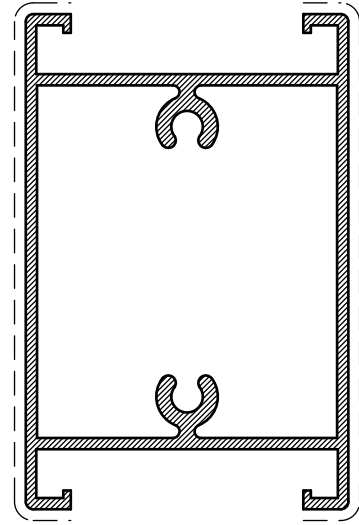

DS 4506

gr/m 1115

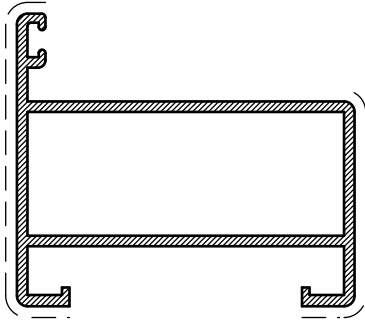

DS 4508

gr/m 636

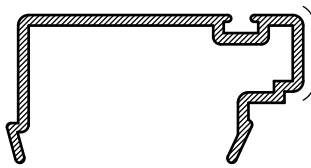

DS 4520

gr/m 307

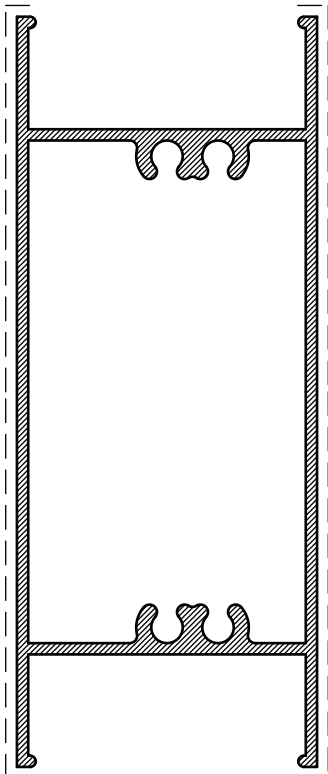

F391

gr/m 1340

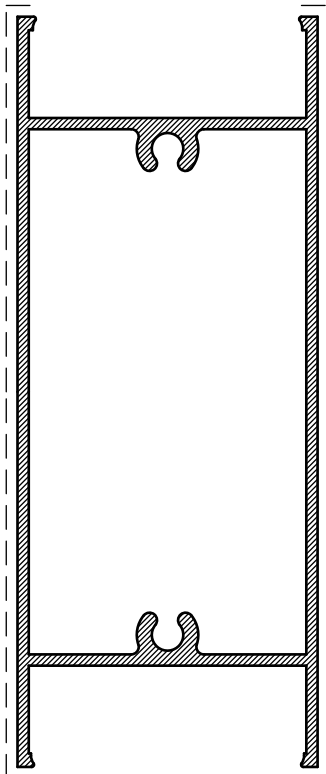

F382

gr/m 1264

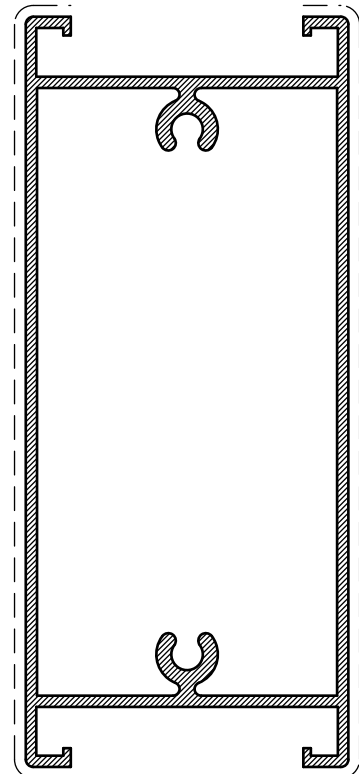

DS 4507

gr/m 1391

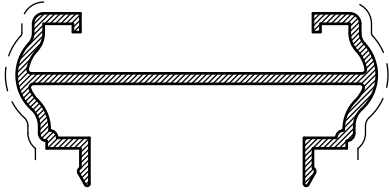

DS 4510

gr/m 427

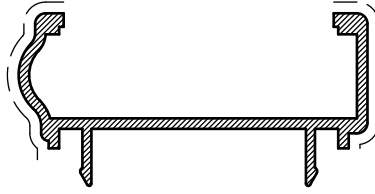

DS 4511

gr/m 383

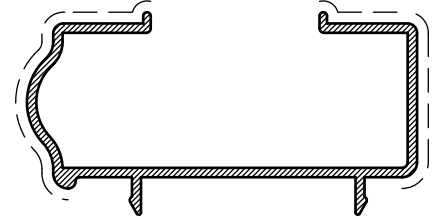

DS 4516

gr/m 423

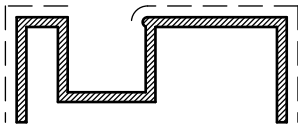

11/38

gr/m 286

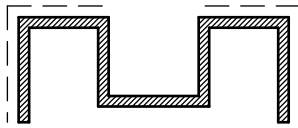

18/3389

gr/m 311

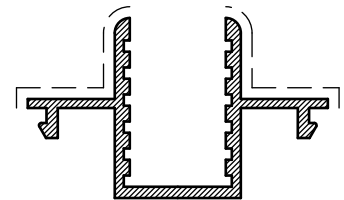

F392

gr/m 384

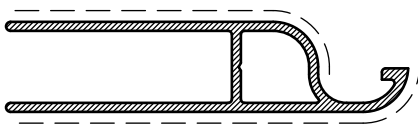

18/2856

gr/m 381

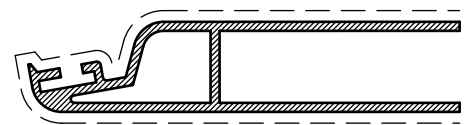

18/3390

gr/m 446



8/34

gr/m 349

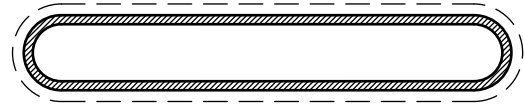

8/70

gr/m 446

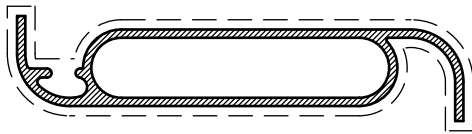

8/83

gr/m 410

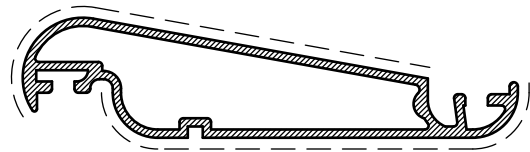

8/157

gr/m 500

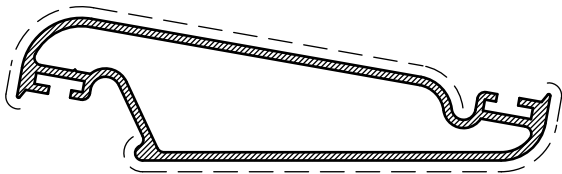

8/223

gr/m 532

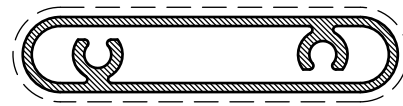

8/250

gr/m 554



8/131

gr/m 486

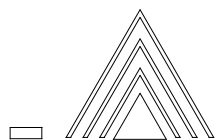

alu-mec

NODO LATERALE SENZA TELAIO A MURO
CON DS 4595 E CORNICE ORNAMENTALE

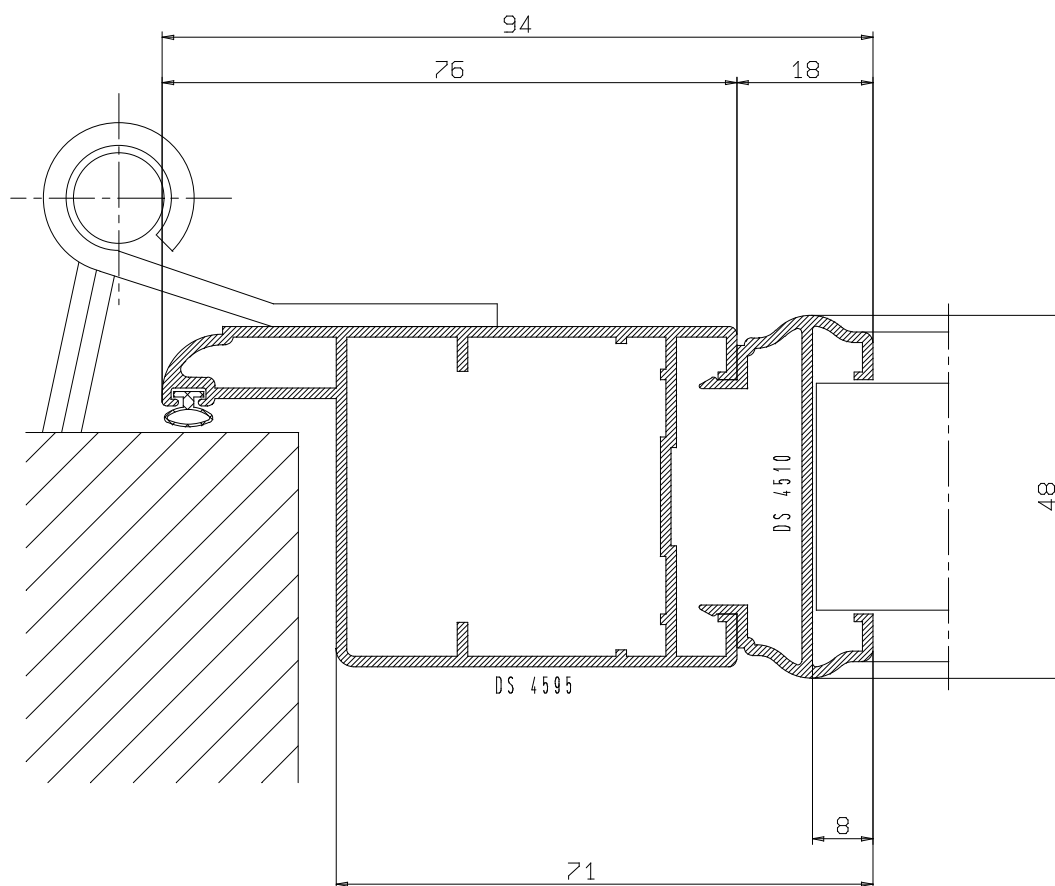

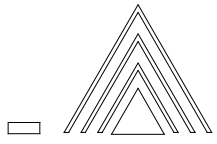

alu-mec

NODO CENTRALE CON DS 4503

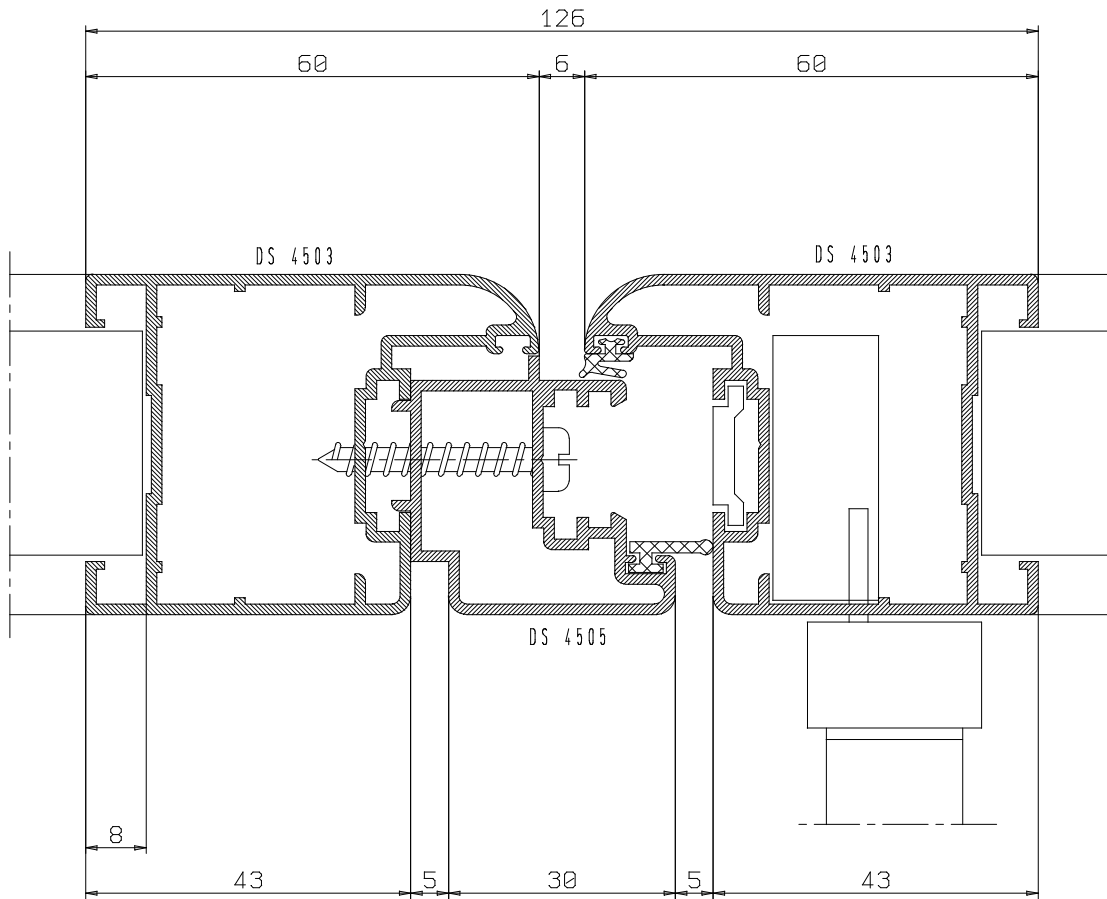

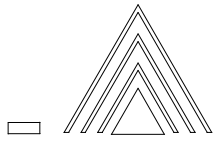

alu-mec

NODO CENTRALE CON DS 4503
E CORNICE ORNAMENTALE

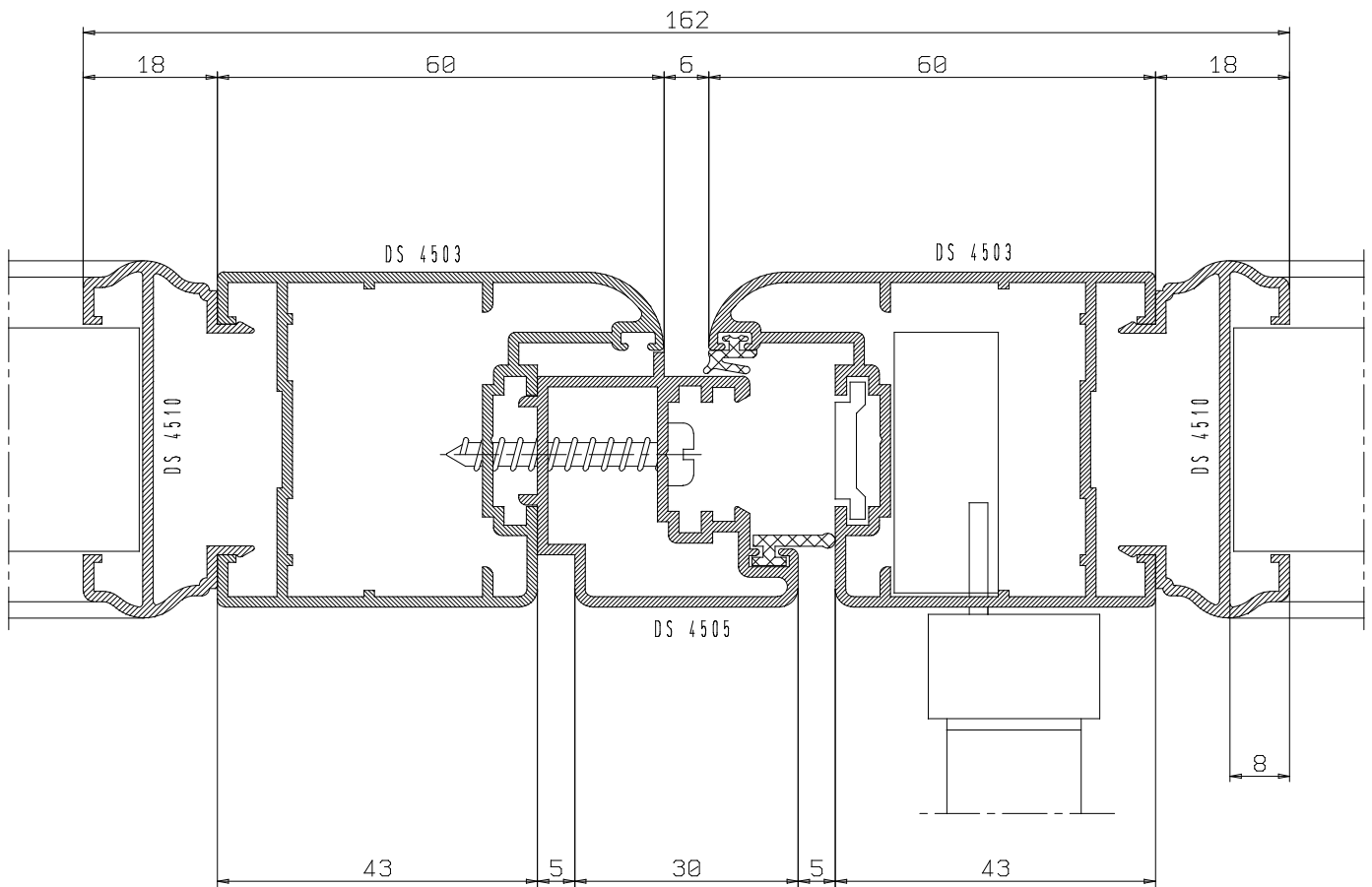

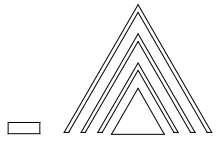

NODO CENTRALE CON DS 4514

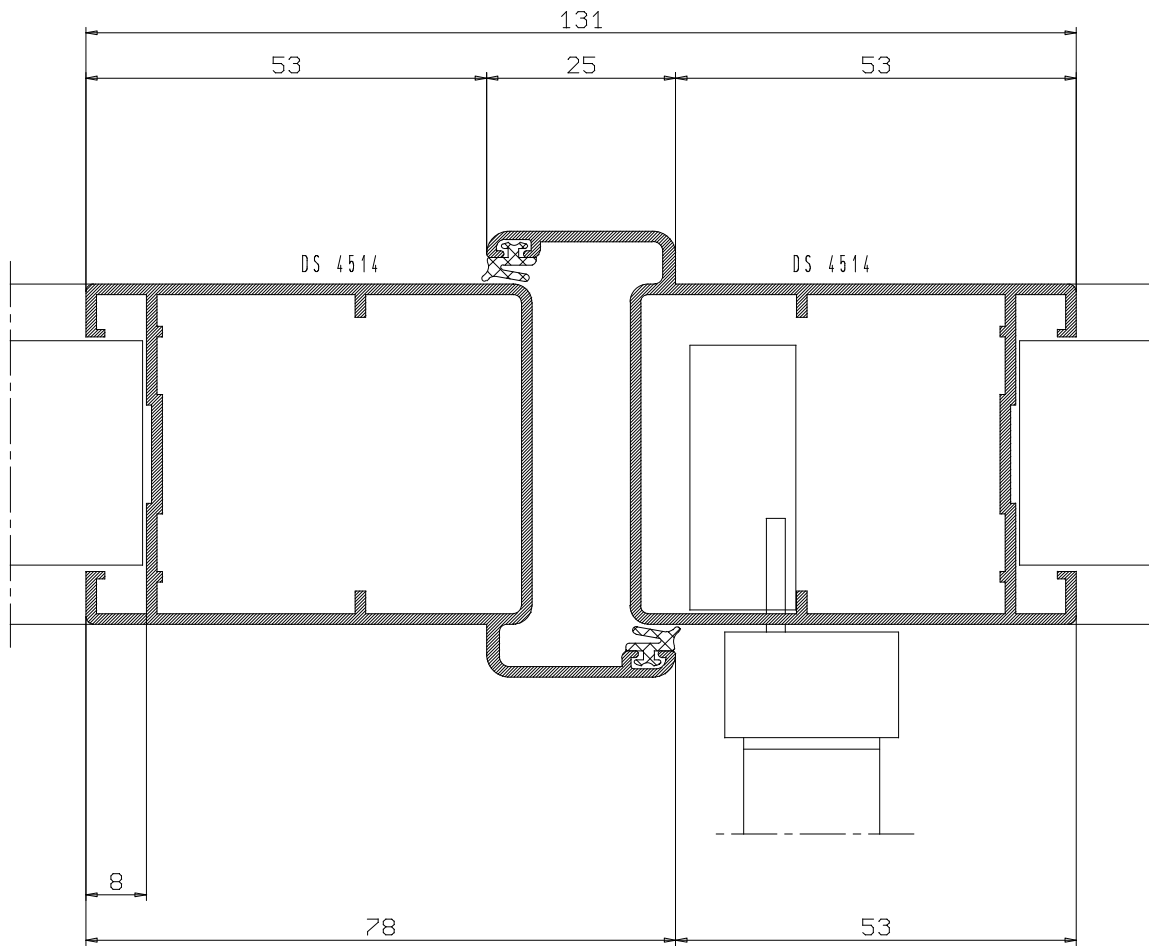

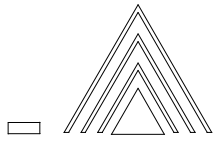

alu-mec

NODO CENTRALE CON DS 4595

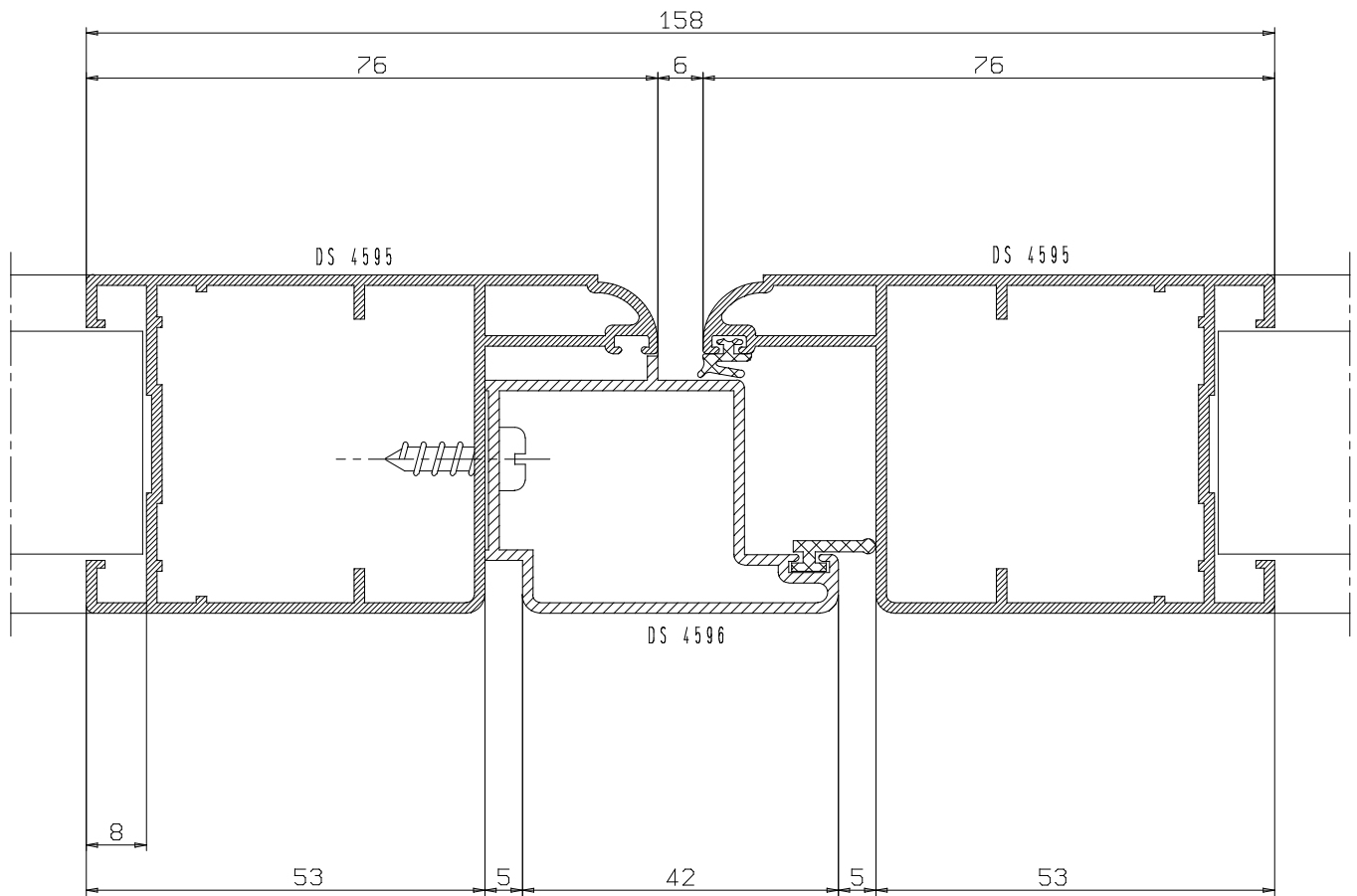

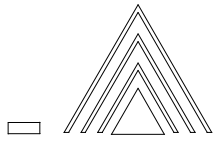

alu-mec

NODO INFERIORE CON DS 4507
E CORNICE ORNAMENTALE

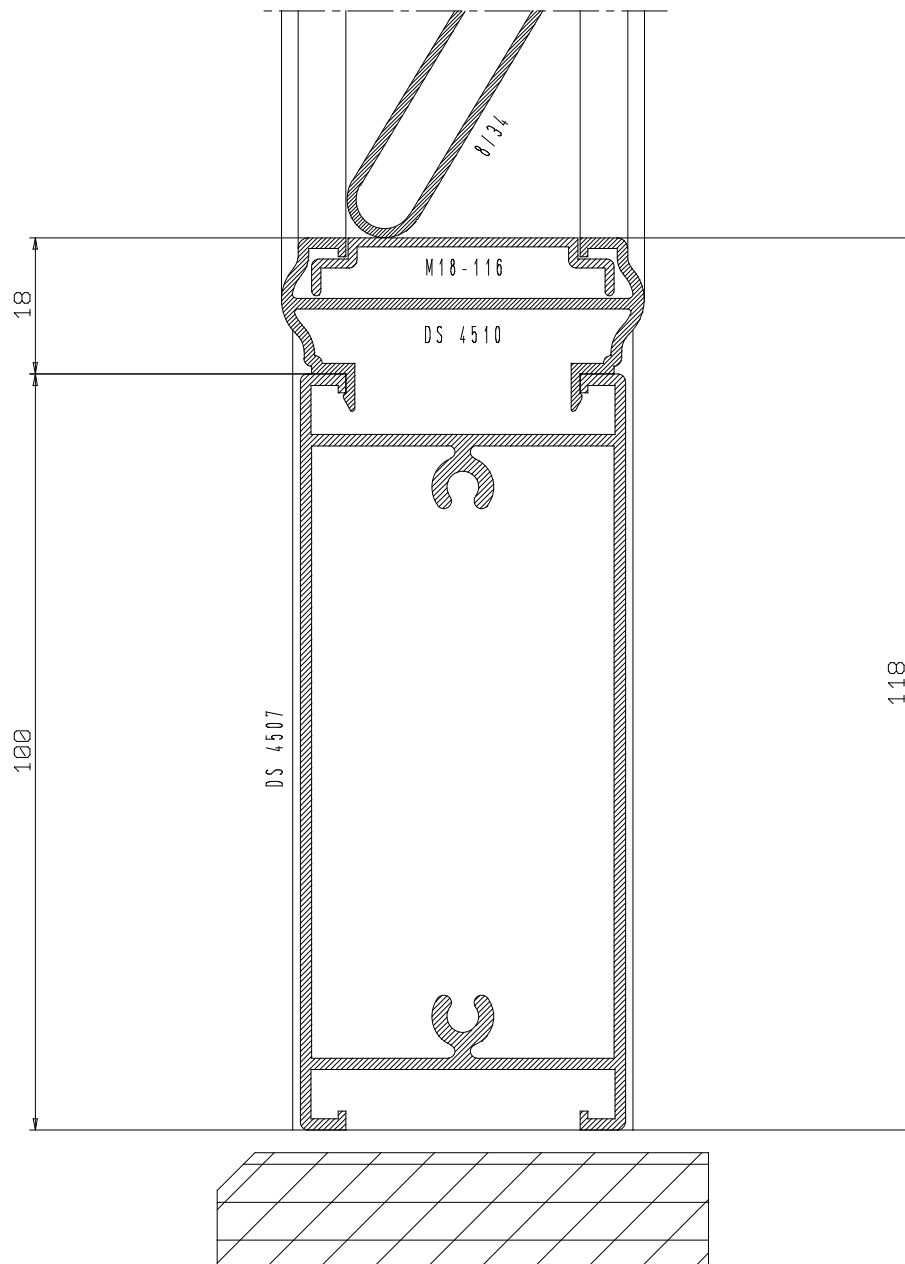

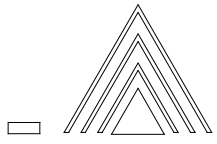

alu-mec

NODO INTERMEDIO CON DS 4506
E CORNICE ORNAMENTALE

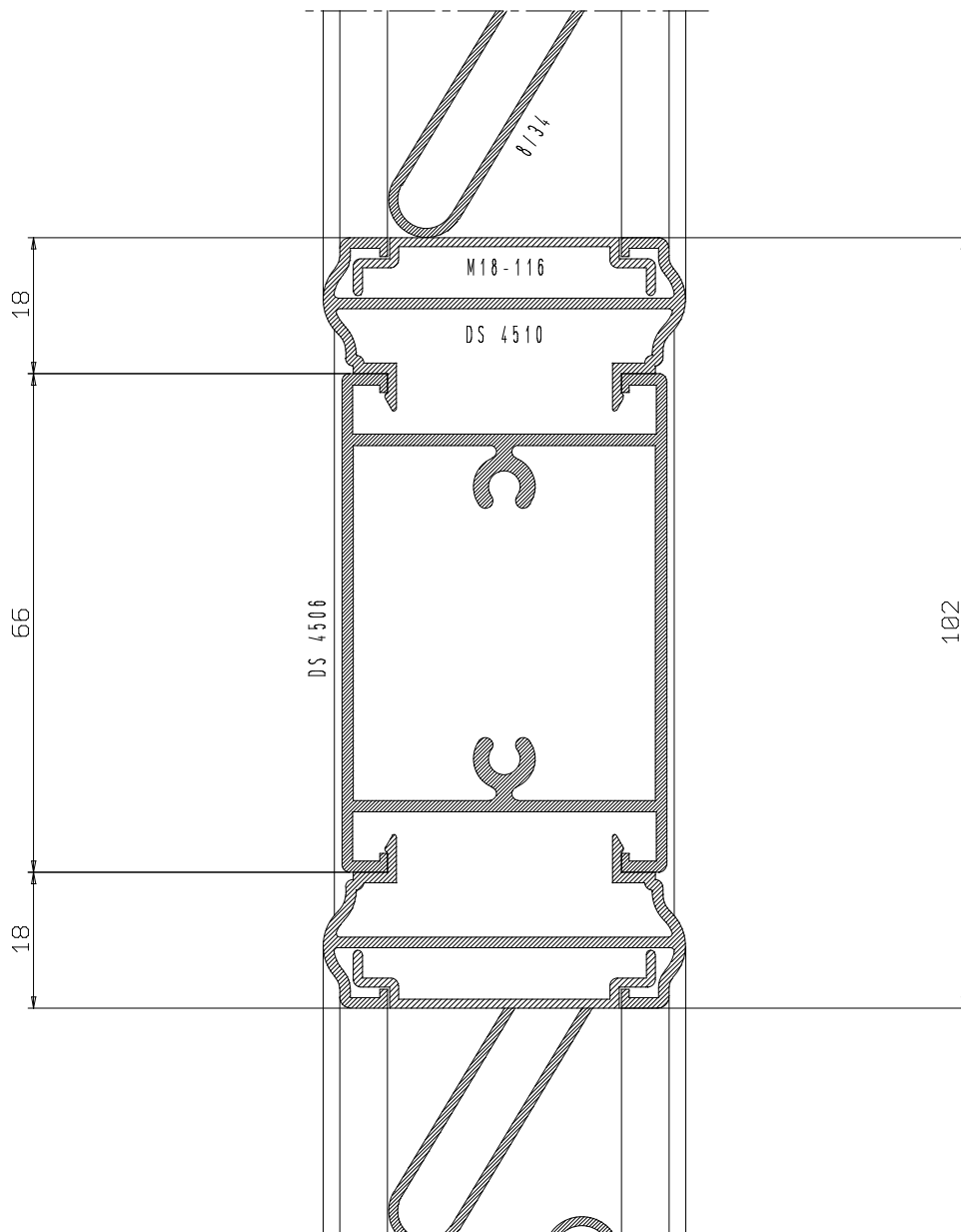

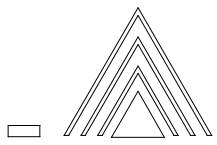

alu-mec

NODO LATERALE CON TELAIO
A MURO E DS 4502

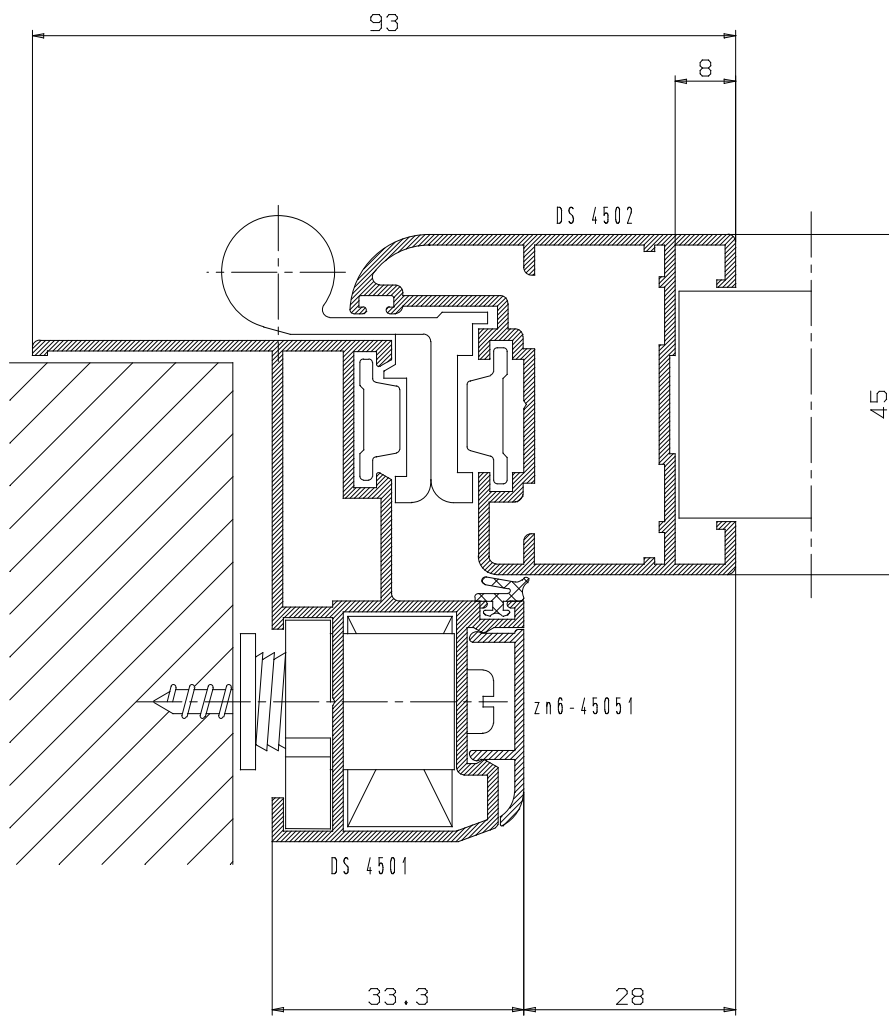

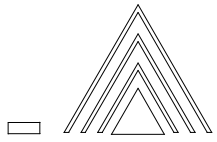

alu-mec

NODO LATERALE CON TELAIO
A MURO E DS 4503

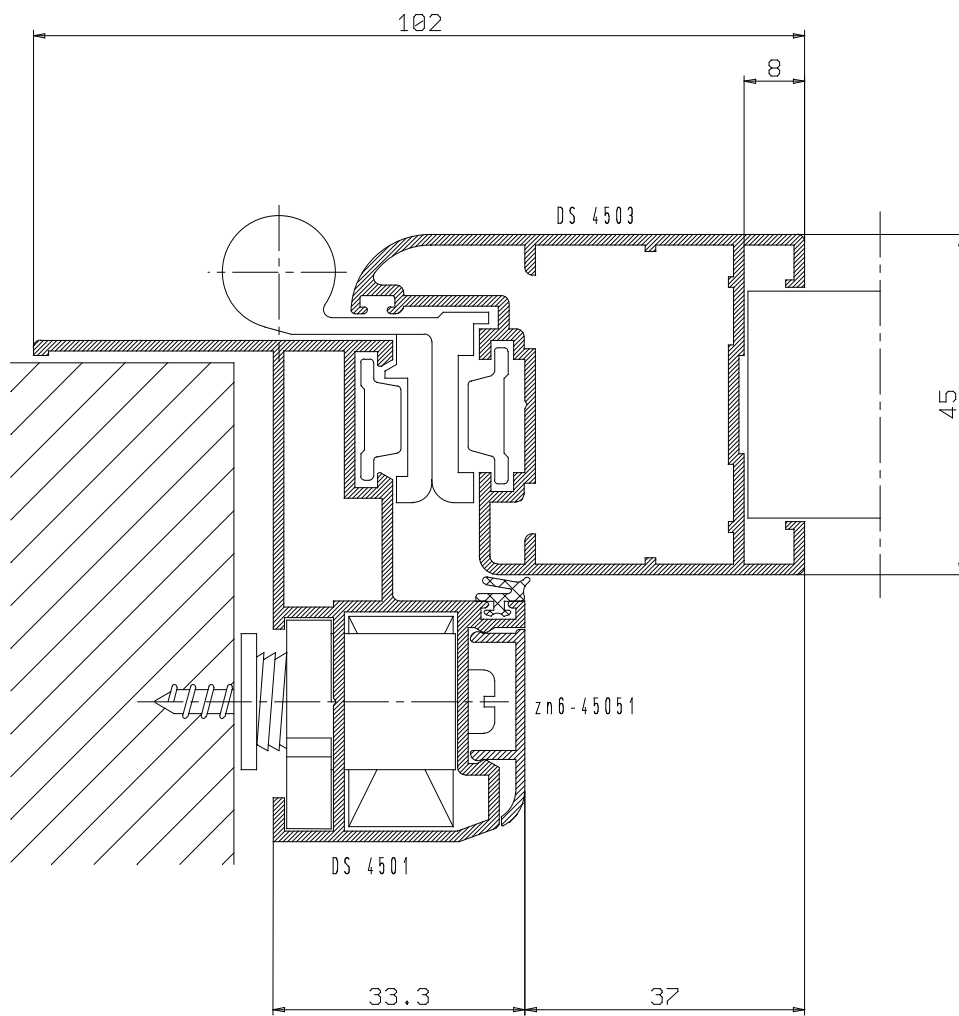

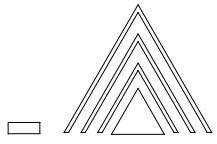

alu-mec

NODO LATERALE CON TELAIO
A MURO E DS 4504

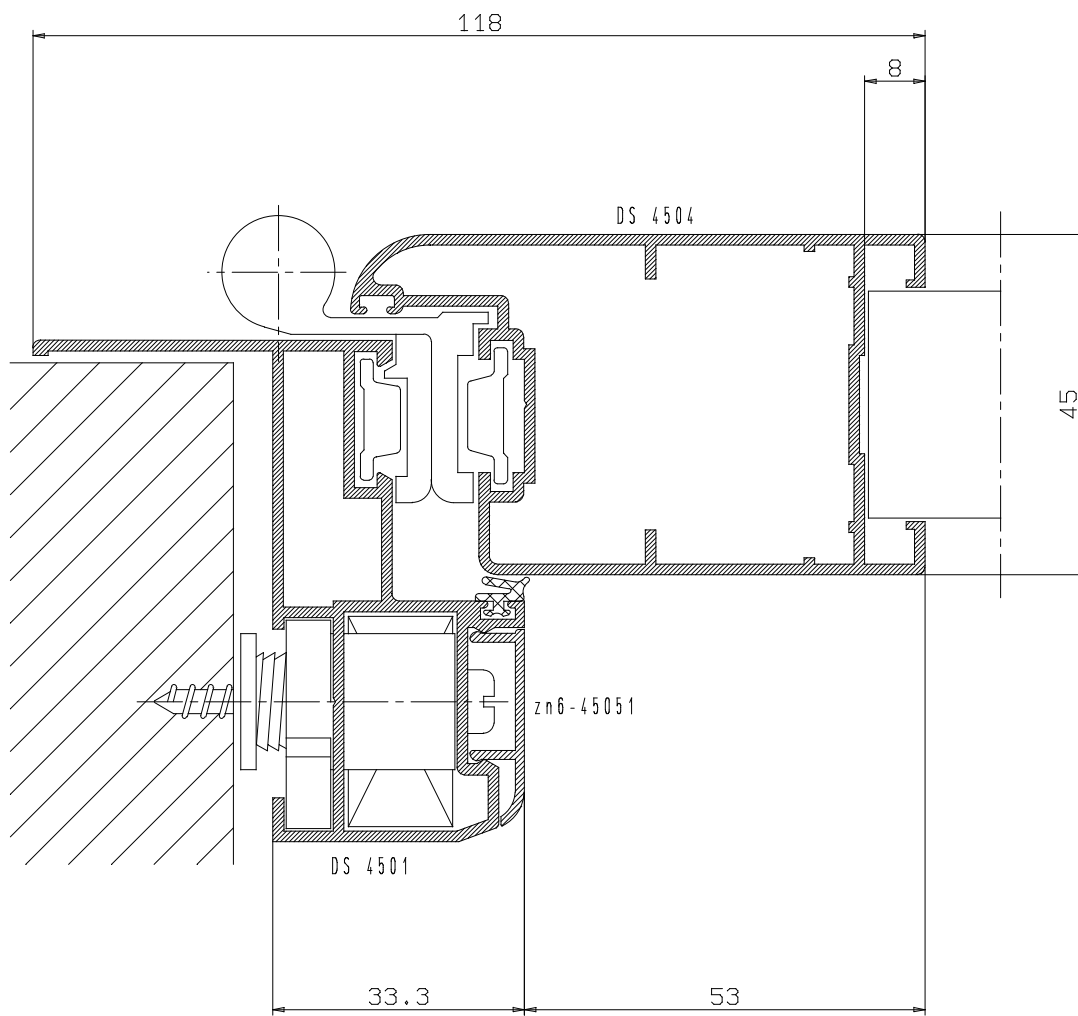

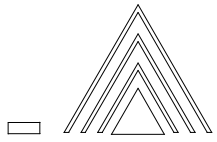

NODO LATERALE CON TELAIO
A MURO DS 4515

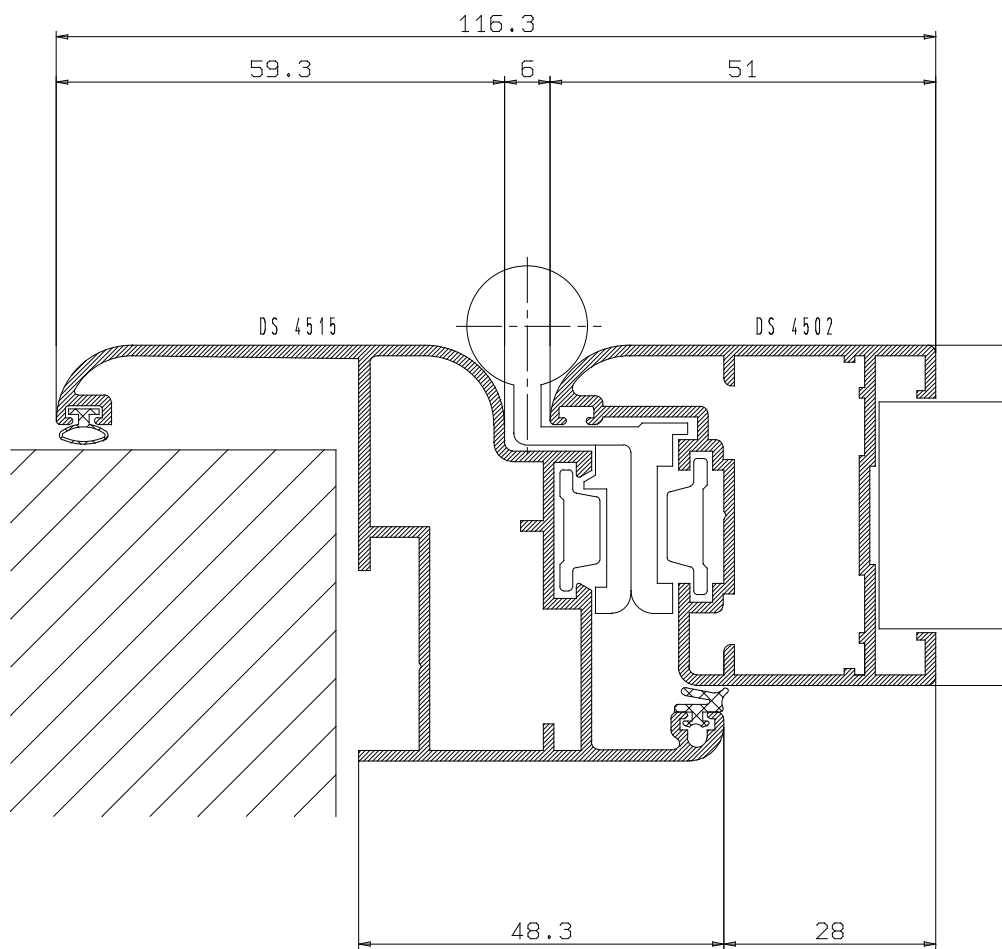

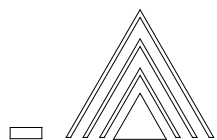

alu-mec

NODO LATERALE CON TELAIO A MURO
E SPORTELLO A SPORGERE

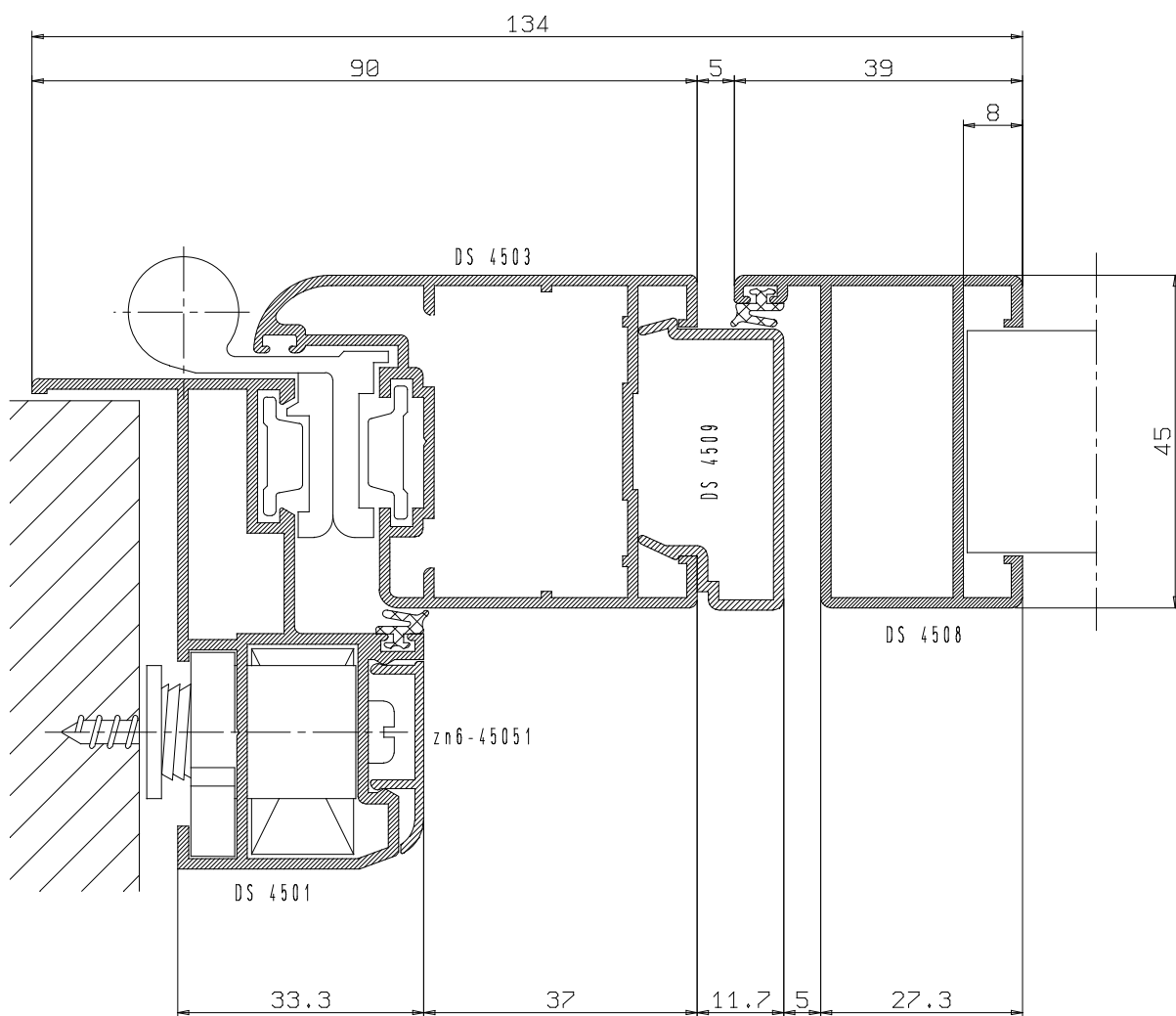

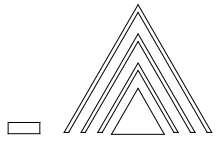

alu-mec

NODO LATERALE CON TELAIO
A MURO ZN6-45066

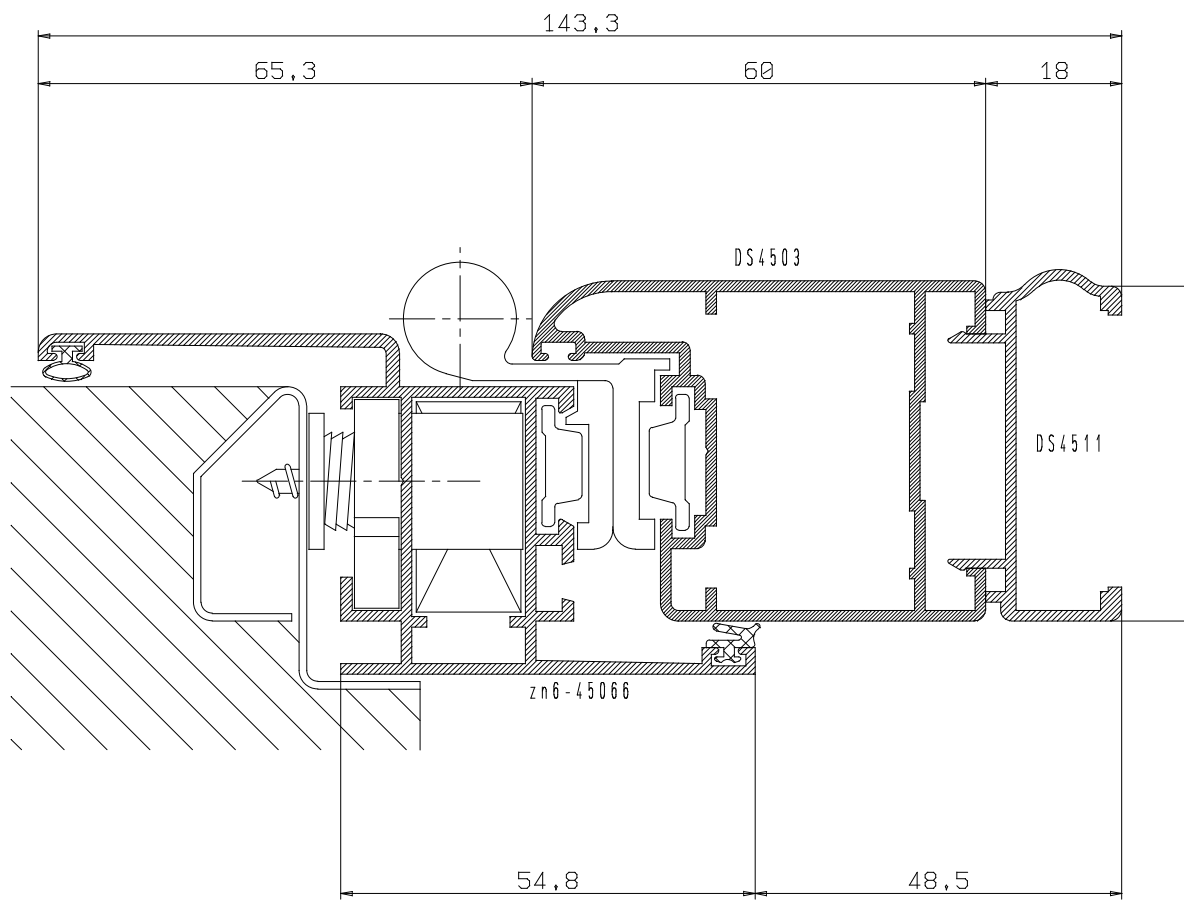

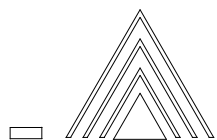

alu-mec

NODO LATERALE SENZA BATTUTA A MURO
E SPORTELLO A SPORGERE

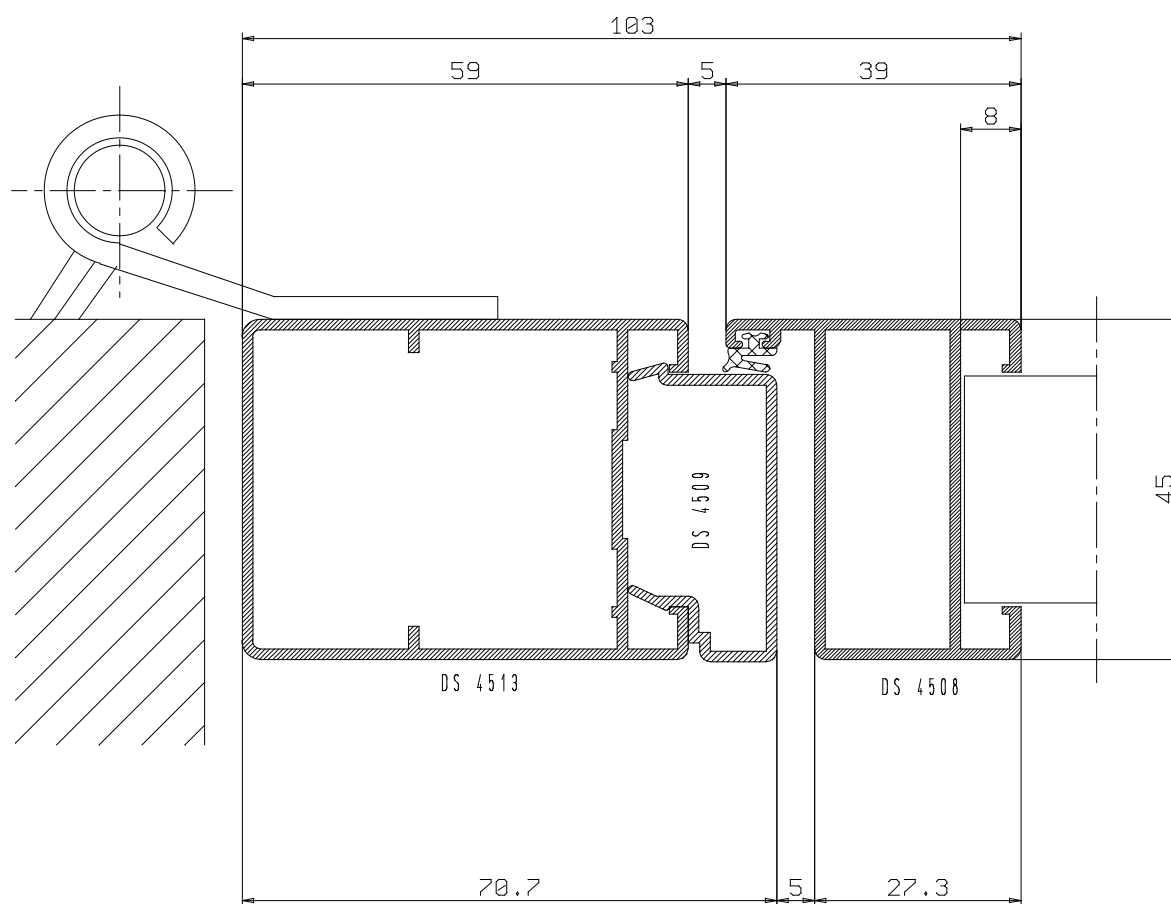

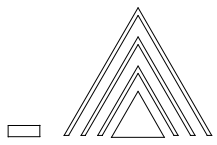



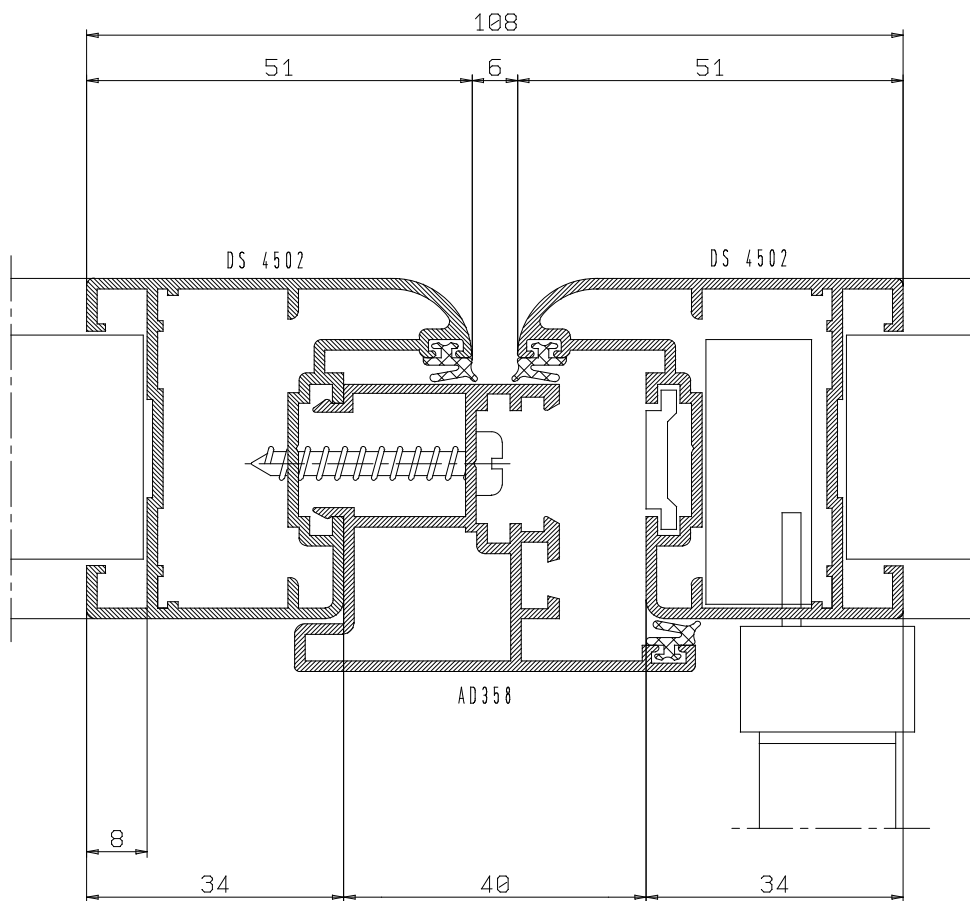

alu-mec

NODO CENTRALE CON DS 4502

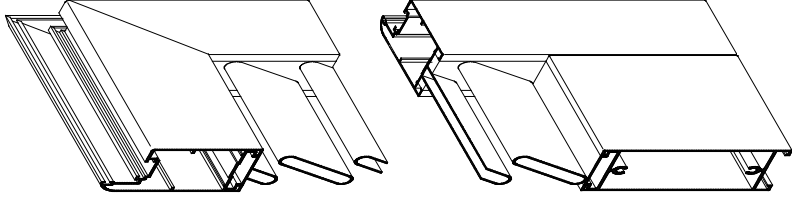
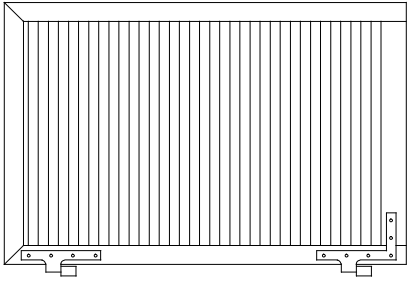

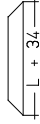
PERSIANA AD UN'ANTA SENZA TELAIO FISSO

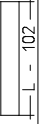

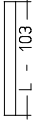
articolo	taglio	n° pez	lav
DS 4504		1	
DS 4504		2	1dx 1sx
DS 4507		1	
M18-116		2	
8/34			

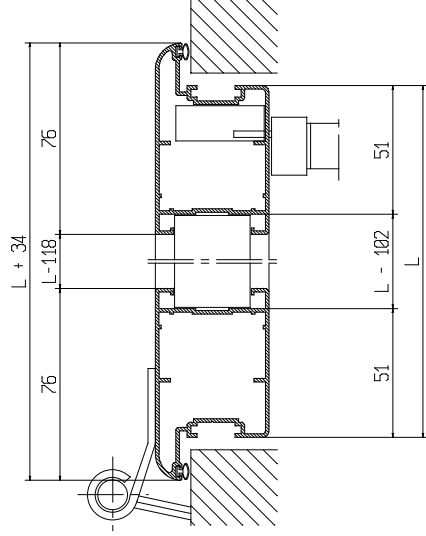
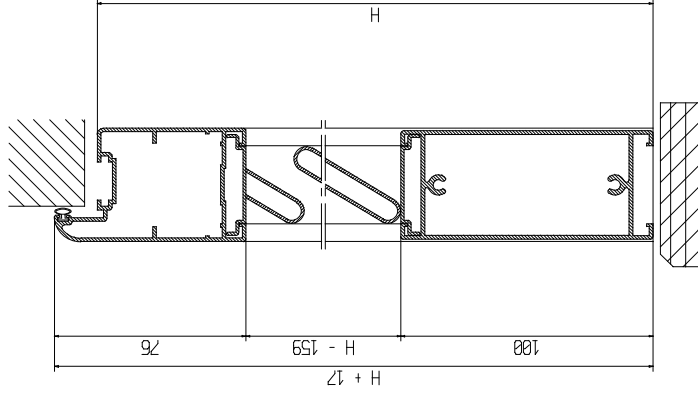

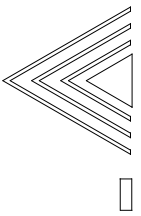

alu-mec

PERSIANA A DUE ANTE CON DS 4504

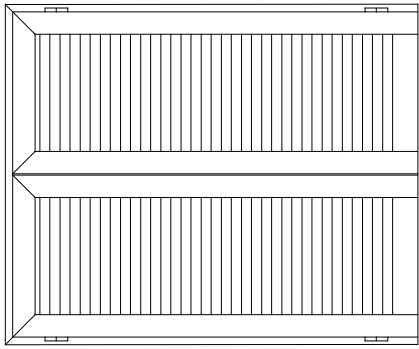

articolo	taglio	n° pez	lav
DS 4501	L + 63,4	1	
DS 4501	H + 31,7	2	1dx 1sx
DS 4504	L/2 - 13,3	2	
DS 4504	H - 15,3	4	2dx 2sx
DS 4505	H - 33,8	1	
DS 4507	L/2 - 149,3	2	
Zn6-45051	L - 52,2	1	
Zn6-45051	H - 26,1	2	
M18-116	L/2 - 149,3	4	
8 / 34	L/2 - 150,3		

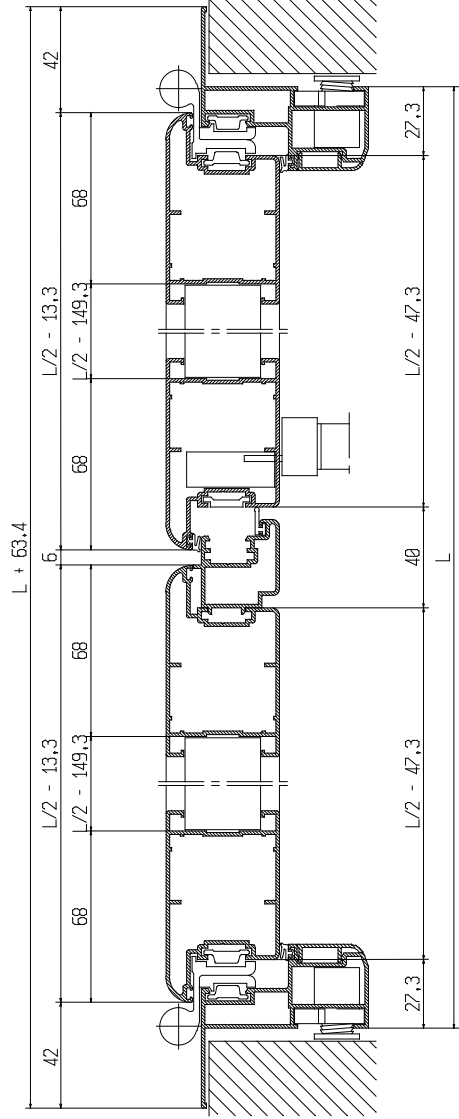
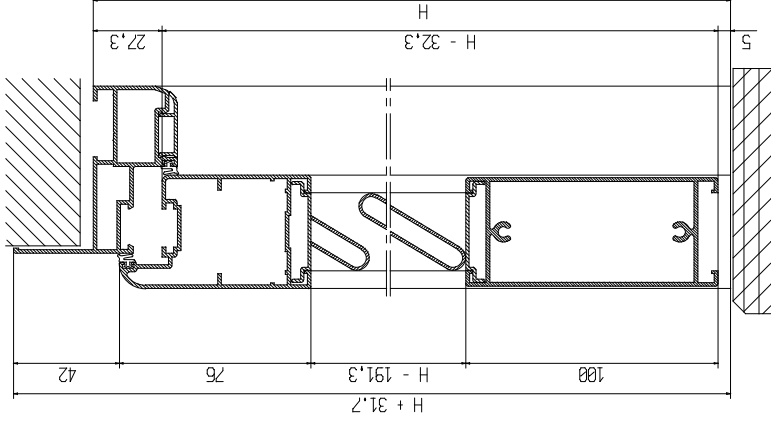
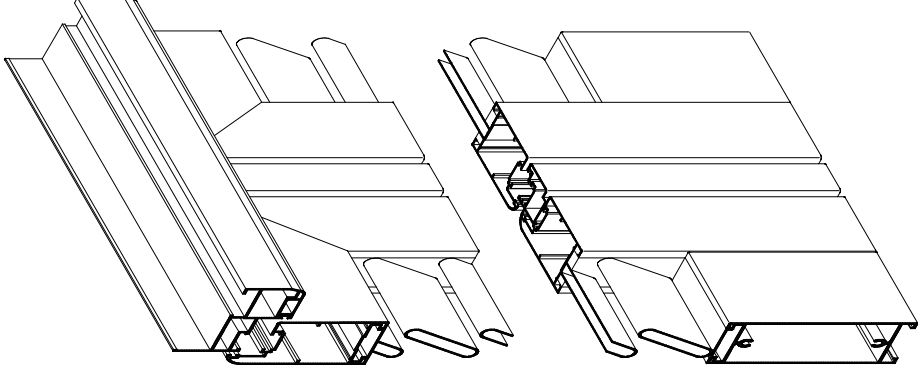

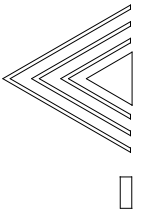

alu-mec

PERSIANA A DUE ANTE CON TELAIO DS 4515 E CORNICE ORNAMENTALE

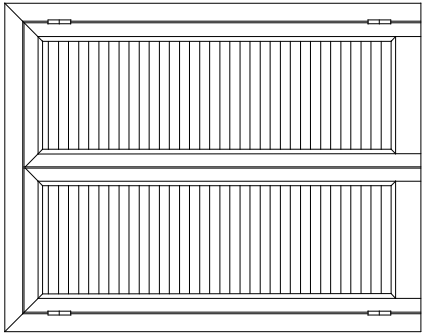

articolo	taglio	n° pez	lav
DS 4515		1	
DS 4515		2	1dx 1sx
DS 4502		2	
DS 4502		4	2dx 2sx
DS 4505		1	
DS 4507		2	
DS 4510		4	
DS 4510		4	
M18 - 116		4	
8 / 34			

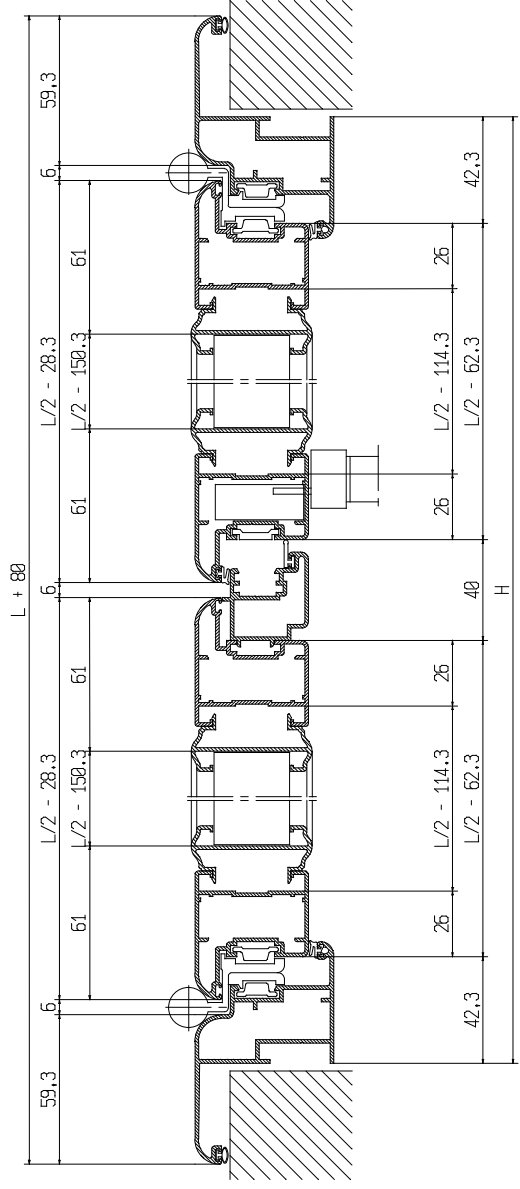
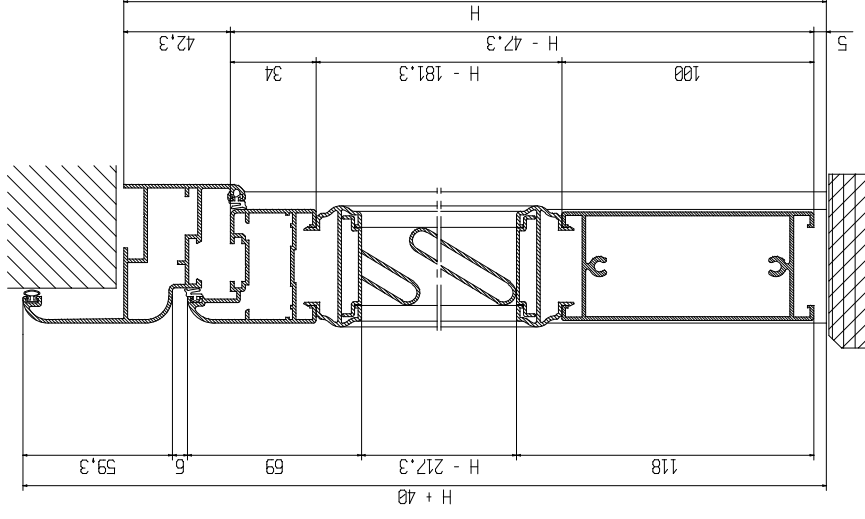

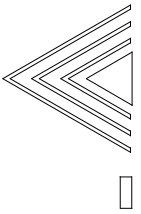

alu-mec

PERSIANA A DUE ANTE SENZA BATTUTA A MURO
E CON SPORTELLO APRIBILE A SPORGERE

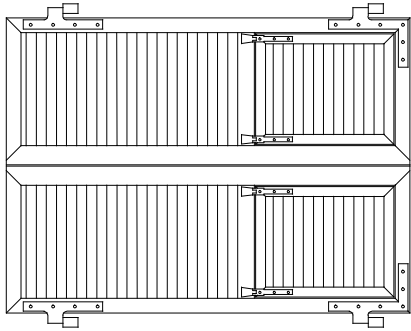

articolo	taglio	n° pez	lav
DS 4513	L	2	
DS 4513	H	2	
DS 4504	H + 34	2	
DS 4505	H - 3	1	
DS 4506	L/2 - 122	2	
DS 4508	L/2 - 148	4	
DS 4508	X + 78	4	
DS 4509	L/2 - 122	4	
DS 4509	X + 104	4	
M18 - 116	L/2 - 122	4	
M18 - 116	L/2 - 210	4	
8 / 34	L/2 - 123		
8 / 34	L/2 - 211		

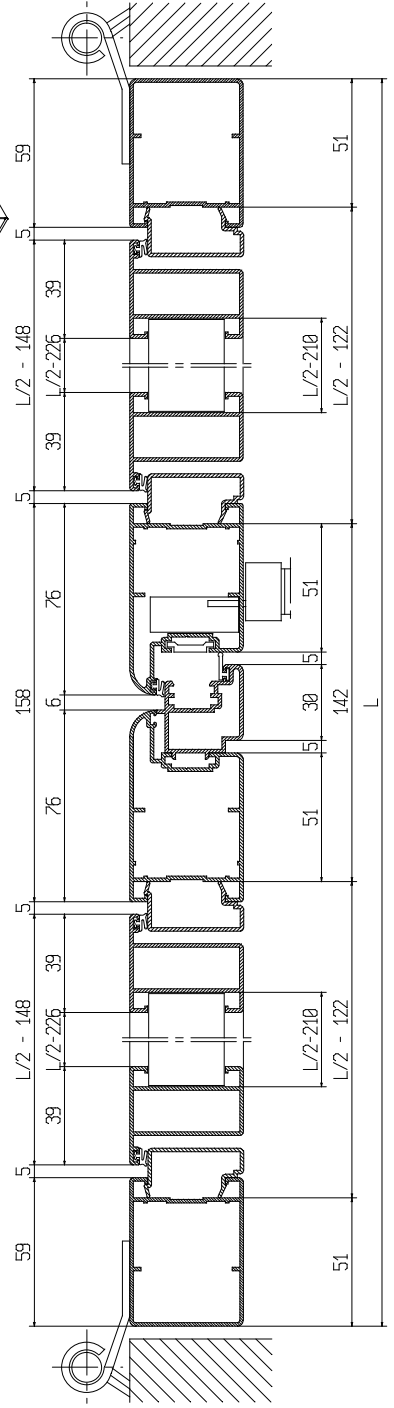
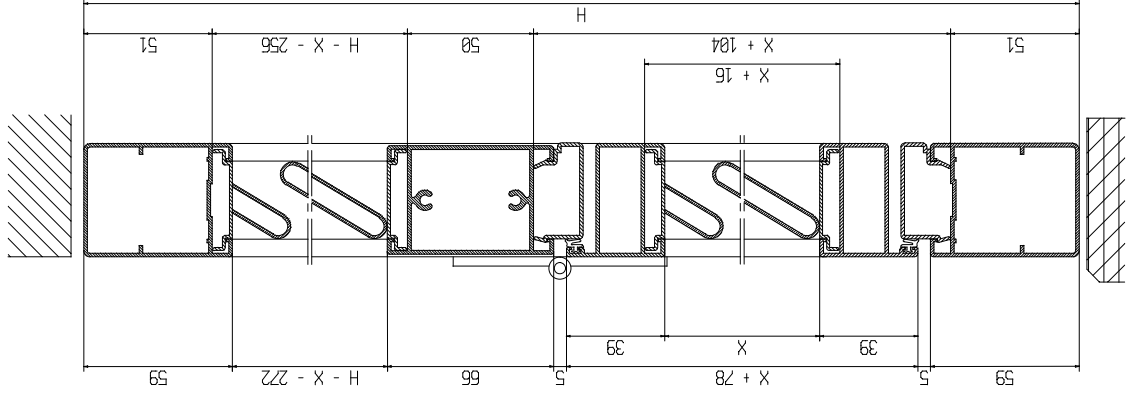
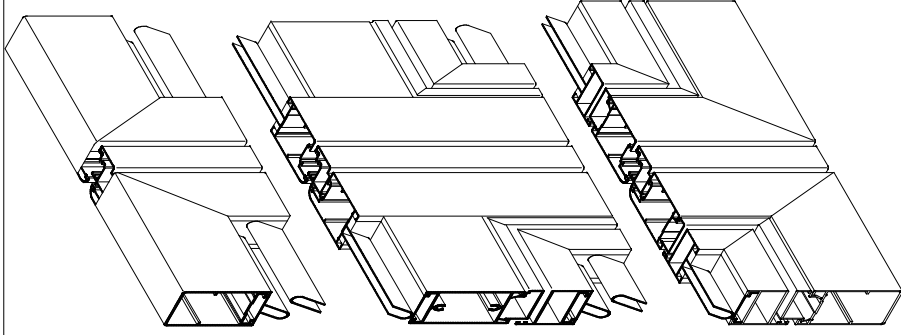



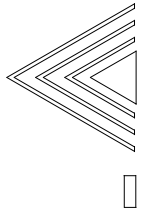



scala 1:3

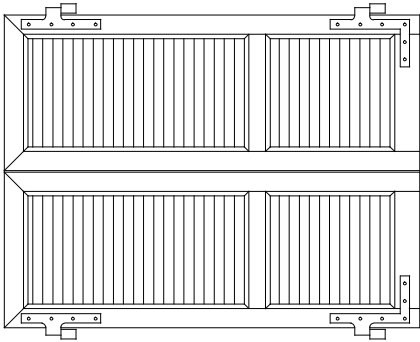

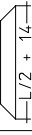
alu-mec

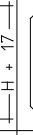
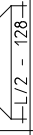
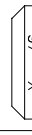
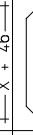
PERSIANA A DUE ANTE SENZA TELAIO FISSO

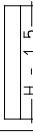

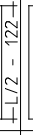
articolo	taglio	n° pez	lav
DS 4504		2	
DS 4504		4	2dx 2sx
DS 4510		8	
DS 4510		4	
DS 4510		4	
DS 4505		1	
DS 4506		2	
DS 4507		2	
M18-116		8	
8/34			

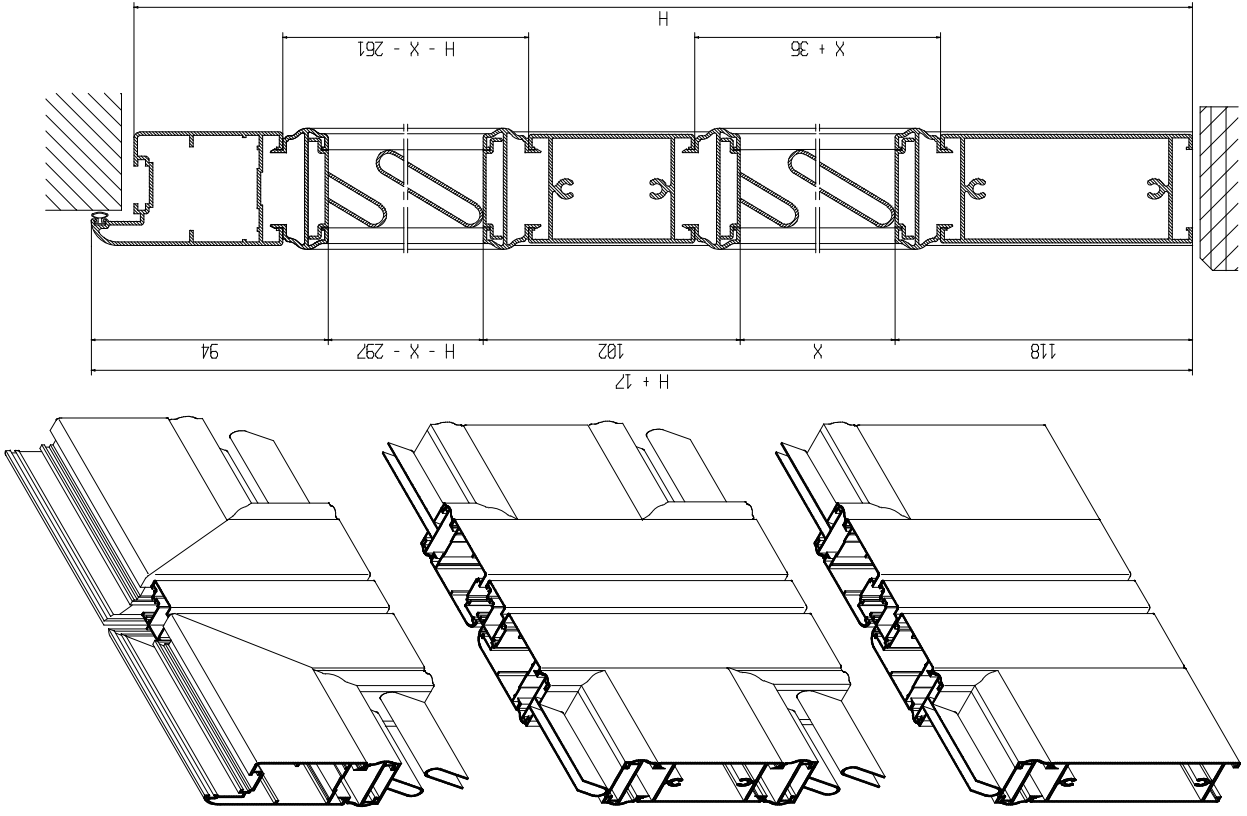

scala 1:3

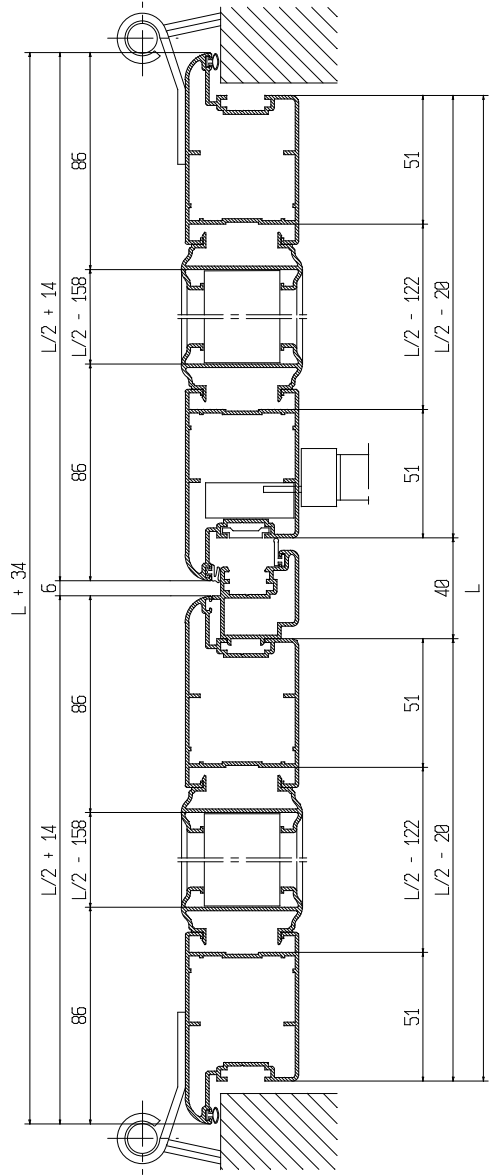

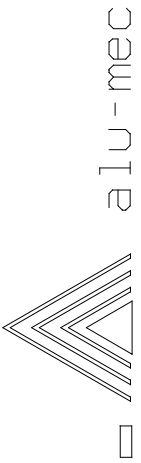

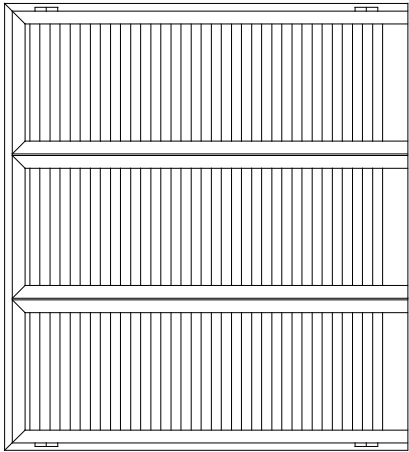

alu-mec

PERSIANA A TRE ANTE CON DS 4503

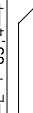
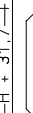

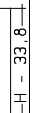
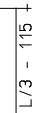
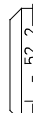
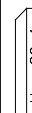
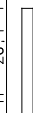
articolo	taglio	n° pez	lav
DS 4501	 L + 63,4	1	
DS 4501	 H + 31,7	2	1dx 1sx
DS 4503	 L/3 - 11	3	
DS 4503	 H - 15,3	6	4dx 4sx
DS 4505	 H - 33,8	2	
DS 4507	 L/3 - 115	3	
zn6-45051	 L - 52,2	1	
zn6-45051	 H - 26,1	2	
M18-116	 L/3 - 115	6	
8/34	 L/3 - 116		

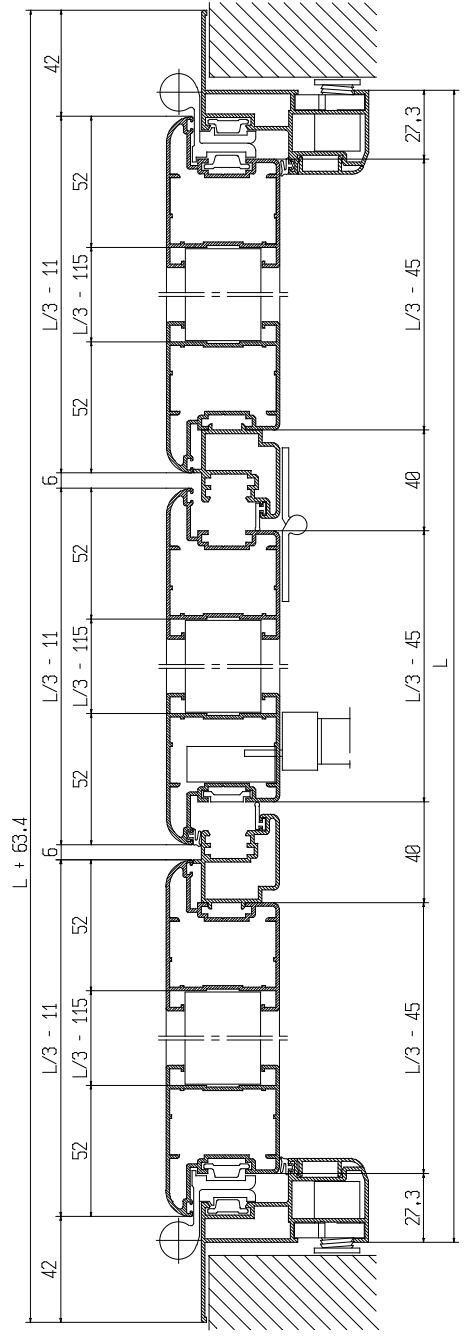
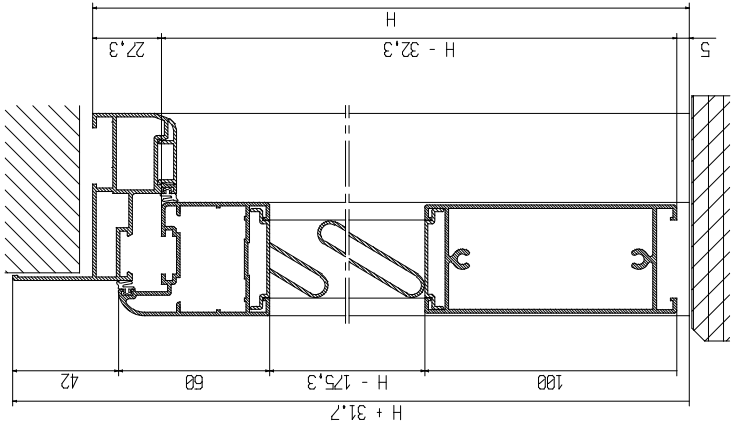

PERSIANA A DUE ANTE CON DS 4502

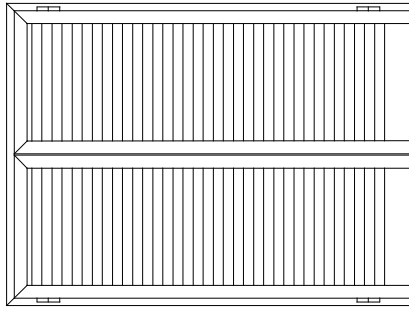

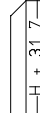
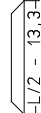
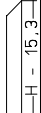
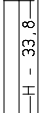
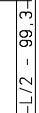
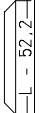
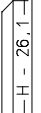
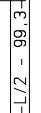
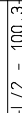
articolo	taglio	n° pez	lav
DS 4501	 L + 63.4	1	
DS 4501	 H + 31.7	2	1dx 1sx
DS 4502	 L/2 - 13.3	2	
DS 4502	 H - 15.3	4	2dx 2sx
DS 4505	 H - 33.8	1	
DS 4507	 L/2 - 99.3	2	
Zn6-45051	 L - 52.2	1	
Zn6-45051	 H - 26.1	2	
M18-116	 L/2 - 99.3	4	
8 / 34	 L/2 - 100.3		

